

APPROVED JURISDICTIONAL DETERMINATION FORM
U.S. Army Corps of Engineers

This form should be completed by following the instructions provided in Section IV of the JD Form Instructional Guidebook.

SECTION I: BACKGROUND INFORMATION

A. REPORT COMPLETION DATE FOR APPROVED JURISDICTIONAL DETERMINATION (JD): December 15, 2016

B. DISTRICT OFFICE, FILE NAME, AND NUMBER: CENAB-OP-M 2016-61190 (Brown's Wharf LLC/Pier)

PROJECT LOCATION AND BACKGROUND INFORMATION:

State: MD County: City: Baltimore City

Center coordinates of site (lat/long in degree decimal format): Lat. N 39°16'50.55", Long. W-76°35'37.10"

Name of nearest Traditional Navigable Water (TNW) into which the aquatic resource flows: Patapsco River

Name of watershed or Hydrologic Unit Code (HUC): 020600

Check if map/diagram of review area and/or potential jurisdictional areas is/are available upon request.

Check if other sites (e.g., offsite mitigation sites, disposal sites, etc...) are associated with this action and are recorded on a different JD form.

D. REVIEW PERFORMED FOR SITE EVALUATION (CHECK ALL THAT APPLY):

Office (Desk) Determination. Date: August 18, 2016

Field Determination. Date(s):

SECTION II: SUMMARY OF FINDINGS

A. RHA SECTION 10 DETERMINATION OF JURISDICTION.

There are "navigable waters of the U.S." within Rivers and Harbors Act (RHA) jurisdiction (as defined by 33 CFR part 329) in the review area. [Required]

Waters subject to the ebb and flow of the tide.

Waters are presently used, or have been used in the past, or may be susceptible for use to transport interstate or foreign commerce.

Explain:

B. CWA SECTION 404 DETERMINATION OF JURISDICTION.

There are "waters of the U.S." within Clean Water Act (CWA) jurisdiction (as defined by 33 CFR part 328) in the review area. [Required]

1. Waters of the U.S.

a. Indicate presence of waters of U.S. in review area (check all that apply):¹

- TNWs, including territorial seas
- Wetlands adjacent to TNWs
- Relatively permanent waters² (RPWs) that flow directly or indirectly into TNWs
- Non-RPWs that flow directly or indirectly into TNWs
- Wetlands directly abutting RPWs that flow directly or indirectly into TNWs
- Wetlands adjacent to but not directly abutting RPWs that flow directly or indirectly into TNWs
- Wetlands adjacent to non-RPWs that flow directly or indirectly into TNWs
- Impoundments of jurisdictional waters
- Isolated (interstate or intrastate) waters, including isolated wetlands

b. Identify (estimate) size of waters of the U.S. in the review area:

Non-wetland waters: 300 linear feet: 87 width (ft) and/or acres.

Wetlands: acres.

c. Limits (boundaries) of jurisdiction based on: Pick List

Elevation of established OHWM (if known):

2. Non-regulated waters/wetlands (check if applicable):³

Potentially jurisdictional waters and/or wetlands were assessed within the review area and determined to be not jurisdictional.

Explain:

¹ Boxes checked below shall be supported by completing the appropriate sections in Section III below.

² For purposes of this form, an RPW is defined as a tributary that is not a TNW and that typically flows year-round or has continuous flow at least "seasonally" (e.g., typically 3 months).

³ Supporting documentation is presented in Section III.F.

SECTION III: CWA ANALYSIS

A. TNWs AND WETLANDS ADJACENT TO TNWs

The agencies will assert jurisdiction over TNWs and wetlands adjacent to TNWs. If the aquatic resource is a TNW, complete Section III.A.1 and Section III.D.1. only; if the aquatic resource is a wetland adjacent to a TNW, complete Sections III.A.1 and 2 and Section III.D.1.; otherwise, see Section III.B below.

1. TNW

Identify TNW: Patapsco River

Summarize rationale supporting determination: The Patapsco River is a tidal tributary of the Chesapeake Bay, a traditionally navigable waterway.

2. Wetland adjacent to TNW

Summarize rationale supporting conclusion that wetland is "adjacent":

B. CHARACTERISTICS OF TRIBUTARY (THAT IS NOT A TNW) AND ITS ADJACENT WETLANDS (IF ANY):

This section summarizes information regarding characteristics of the tributary and its adjacent wetlands, if any, and it helps determine whether or not the standards for jurisdiction established under *Rapanos* have been met.

The agencies will assert jurisdiction over non-navigable tributaries of TNWs where the tributaries are "relatively permanent waters" (RPWs), i.e. tributaries that typically flow year-round or have continuous flow at least seasonally (e.g., typically 3 months). A wetland that directly abuts an RPW is also jurisdictional. If the aquatic resource is not a TNW, but has year-round (perennial) flow, skip to Section III.D.2. If the aquatic resource is a wetland directly abutting a tributary with perennial flow, skip to Section III.D.4.

A wetland that is adjacent to but that does not directly abut an RPW requires a significant nexus evaluation. Corps districts and EPA regions will include in the record any available information that documents the existence of a significant nexus between a relatively permanent tributary that is not perennial (and its adjacent wetlands if any) and a traditional navigable water, even though a significant nexus finding is not required as a matter of law.

If the waterbody⁴ is not an RPW, or a wetland directly abutting an RPW, a JD will require additional data to determine if the waterbody has a significant nexus with a TNW. If the tributary has adjacent wetlands, the significant nexus evaluation must consider the tributary in combination with all of its adjacent wetlands. This significant nexus evaluation that combines, for analytical purposes, the tributary and all of its adjacent wetlands is used whether the review area identified in the JD request is the tributary, or its adjacent wetlands, or both. If the JD covers a tributary with adjacent wetlands, complete Section III.B.1 for the tributary, Section III.B.2 for any onsite wetlands, and Section III.B.3 for all wetlands adjacent to that tributary, both onsite and offsite. The determination whether a significant nexus exists is determined in Section III.C below.

1. Characteristics of non-TNWs that flow directly or indirectly into TNW

(i) General Area Conditions:

Watershed size: **Pick List**
Drainage area: **Pick List**
Average annual rainfall: inches
Average annual snowfall: inches

(ii) Physical Characteristics:

(a) Relationship with TNW:

- Tributary flows directly into TNW.
 Tributary flows through **Pick List** tributaries before entering TNW.

Project waters are **Pick List** river miles from TNW.
Project waters are **Pick List** river miles from RPW.
Project waters are **Pick List** aerial (straight) miles from TNW.
Project waters are **Pick List** aerial (straight) mile from RPW.
Project waters cross or serve as state boundaries. Explain:

Identify flow route to TNW⁵:

⁴ Note that the Instructional Guidebook contains additional information regarding swales, ditches, washes, and erosional features generally and in the arid West.

⁵ Flow route can be described by identifying, e.g., tributary a, which flows through the review area, to flow into tributary b, which then flows into TNW.

Tributary stream order, if known:

(b) **General Tributary Characteristics (check all that apply):**

Tributary is: Natural
 Artificial (man-made). Explain:
 Manipulated (man-altered). Explain:

Tributary properties with respect to top of bank (estimate):

Average width: feet
Average depth: feet
Average side slopes: **Pick List**.

Primary tributary substrate composition (check all that apply):

Silts Sands Concrete
 Cobbles Gravel Muck
 Bedrock Vegetation. Type/% cover:
 Other. Explain:

Tributary condition/stability [e.g., highly eroding, sloughing banks]. Explain:

Presence of run/riffle/pool complexes. Explain:

Tributary geometry:

Tributary gradient (approximate average slope): %

(c) **Flow:**

Tributary provides for: **Pick List**

Estimate average number of flow events in review area/year: **Pick List**

Describe flow regime:

Other information on duration and volume:

Surface flow is: **Pick List**. **Characteristics:**

Subsurface flow: **Pick List**. **Explain findings:**

Dye (or other) test performed:

Tributary has (check all that apply):

Bed and banks
 OHWM⁶ (check all indicators that apply):
 clear, natural line impressed on the bank the presence of litter and debris
 changes in the character of soil destruction of terrestrial vegetation
 shelving the presence of wrack line
 vegetation matted down, bent, or absent sediment sorting
 leaf litter disturbed or washed away scour
 sediment deposition multiple observed or predicted flow events
 water staining abrupt change in plant community
 other (list):
 Discontinuous OHWM.⁷ Explain:

If factors other than the OHWM were used to determine lateral extent of CWA jurisdiction (check all that apply):

High Tide Line indicated by: Mean High Water Mark indicated by:
 oil or scum line along shore objects survey to available datum;
 fine shell or debris deposits (foreshore) physical markings;
 physical markings/characteristics vegetation lines/changes in vegetation types.
 tidal gauges
 other (list):

(iii) **Chemical Characteristics:**

Characterize tributary (e.g., water color is clear, discolored, oily film; water quality; general watershed characteristics, etc.).

Explain:

Identify specific pollutants, if known:

(iv) **Biological Characteristics. Channel supports (check all that apply):**

⁶A natural or man-made discontinuity in the OHWM does not necessarily sever jurisdiction (e.g., where the stream temporarily flows underground, or where the OHWM has been removed by development or agricultural practices). Where there is a break in the OHWM that is unrelated to the waterbody's flow regime (e.g., flow over a rock outcrop or through a culvert), the agencies will look for indicators of flow above and below the break.

⁷ibid.

- Riparian corridor. Characteristics (type, average width):
- Wetland fringe. Characteristics:
- Habitat for:
 - Federally Listed species. Explain findings:
 - Fish/spawn areas. Explain findings:
 - Other environmentally-sensitive species. Explain findings:
 - Aquatic/wildlife diversity. Explain findings:

2. Characteristics of wetlands adjacent to non-TNW that flow directly or indirectly into TNW

(i) Physical Characteristics:

(a) General Wetland Characteristics:

Properties:

Wetland size: acres

Wetland type. Explain:

Wetland quality. Explain:

Project wetlands cross or serve as state boundaries. Explain:

(b) General Flow Relationship with Non-TNW:

Flow is: Explain:

Surface flow is: **Pick List**

Characteristics:

Subsurface flow: **Pick List**. Explain findings:

Dye (or other) test performed:

(c) Wetland Adjacency Determination with Non-TNW:

Directly abutting

Not directly abutting

Discrete wetland hydrologic connection. Explain:

Ecological connection. Explain:

Separated by berm/barrier. Explain:

(d) Proximity (Relationship) to TNW

Project wetlands are **Pick List** river miles from TNW.

Project waters are **Pick List** aerial (straight) miles from TNW.

Flow is from: **Pick List**.

Estimate approximate location of wetland as within the **Pick List** floodplain.

(ii) Chemical Characteristics:

Characterize wetland system (e.g., water color is clear, brown, oil film on surface; water quality; general watershed characteristics; etc.). Explain:

Identify specific pollutants, if known:

(iii) Biological Characteristics. Wetland supports (check all that apply):

Riparian buffer. Characteristics (type, average width):

Vegetation type/percent cover. Explain:

Habitat for:

Federally Listed species. Explain findings:

Fish/spawn areas. Explain findings:

Other environmentally-sensitive species. Explain findings:

Aquatic/wildlife diversity. Explain findings:

3. Characteristics of all wetlands adjacent to the tributary (if any)

All wetland(s) being considered in the cumulative analysis: **Pick List**

Approximately () acres in total are being considered in the cumulative analysis.

For each wetland, specify the following:

Directly abuts? (Y/N)

Size (in acres)

Directly abuts? (Y/N)

Size (in acres)

Summarize overall biological, chemical and physical functions being performed:

C. SIGNIFICANT NEXUS DETERMINATION

A significant nexus analysis will assess the flow characteristics and functions of the tributary itself and the functions performed by any wetlands adjacent to the tributary to determine if they significantly affect the chemical, physical, and biological integrity of a TNW. For each of the following situations, a significant nexus exists if the tributary, in combination with all of its adjacent wetlands, has more than a speculative or insubstantial effect on the chemical, physical and/or biological integrity of a TNW. Considerations when evaluating significant nexus include, but are not limited to the volume, duration, and frequency of the flow of water in the tributary and its proximity to a TNW, and the functions performed by the tributary and all its adjacent wetlands. It is not appropriate to determine significant nexus based solely on any specific threshold of distance (e.g. between a tributary and its adjacent wetland or between a tributary and the TNW). Similarly, the fact an adjacent wetland lies within or outside of a floodplain is not solely determinative of significant nexus.

Draw connections between the features documented and the effects on the TNW, as identified in the *Rapanos* Guidance and discussed in the Instructional Guidebook. Factors to consider include, for example:

- Does the tributary, in combination with its adjacent wetlands (if any), have the capacity to carry pollutants or flood waters to TNWs, or to reduce the amount of pollutants or flood waters reaching a TNW?
- Does the tributary, in combination with its adjacent wetlands (if any), provide habitat and lifecycle support functions for fish and other species, such as feeding, nesting, spawning, or rearing young for species that are present in the TNW?
- Does the tributary, in combination with its adjacent wetlands (if any), have the capacity to transfer nutrients and organic carbon that support downstream foodwebs?
- Does the tributary, in combination with its adjacent wetlands (if any), have other relationships to the physical, chemical, or biological integrity of the TNW?

Note: the above list of considerations is not inclusive and other functions observed or known to occur should be documented below:

1. **Significant nexus findings for non-RPW that has no adjacent wetlands and flows directly or indirectly into TNWs.** Explain findings of presence or absence of significant nexus below, based on the tributary itself, then go to Section III.D:
2. **Significant nexus findings for non-RPW and its adjacent wetlands, where the non-RPW flows directly or indirectly into TNWs.** Explain findings of presence or absence of significant nexus below, based on the tributary in combination with all of its adjacent wetlands, then go to Section III.D:
3. **Significant nexus findings for wetlands adjacent to an RPW but that do not directly abut the RPW.** Explain findings of presence or absence of significant nexus below, based on the tributary in combination with all of its adjacent wetlands, then go to Section III.D:

D. DETERMINATIONS OF JURISDICTIONAL FINDINGS. THE SUBJECT WATERS/WETLANDS ARE (CHECK ALL THAT APPLY):

1. **TNWs and Adjacent Wetlands.** Check all that apply and provide size estimates in review area:

TNWs: <1 acre.

Wetlands adjacent to TNWs: _____ acres.

2. **RPWs that flow directly or indirectly into TNWs.**

Tributaries of TNWs where tributaries typically flow year-round are jurisdictional. Provide data and rationale indicating that tributary is perennial:

Tributaries of TNW where tributaries have continuous flow "seasonally" (e.g., typically three months each year) are jurisdictional. Data supporting this conclusion is provided at Section III.B. Provide rationale indicating that tributary flows seasonally:

Provide estimates for jurisdictional waters in the review area (check all that apply):

Tributary waters: linear feet width (ft).

Other non-wetland waters: acres.

Identify type(s) of waters:

3. Non-RPWs⁸ that flow directly or indirectly into TNWs.

- Waterbody that is not a TNW or an RPW, but flows directly or indirectly into a TNW, and it has a significant nexus with a TNW is jurisdictional. Data supporting this conclusion is provided at Section III.C.

Provide estimates for jurisdictional waters within the review area (check all that apply):

Tributary waters: linear feet width (ft).

Other non-wetland waters: acres.

Identify type(s) of waters:

4. Wetlands directly abutting an RPW that flow directly or indirectly into TNWs.

- Wetlands directly abut RPW and thus are jurisdictional as adjacent wetlands.

Wetlands directly abutting an RPW where tributaries typically flow year-round. Provide data and rationale indicating that tributary is perennial in Section III.D.2, above. Provide rationale indicating that wetland is directly abutting an RPW:

Wetlands directly abutting an RPW where tributaries typically flow "seasonally." Provide data indicating that tributary is seasonal in Section III.B and rationale in Section III.D.2, above. Provide rationale indicating that wetland is directly abutting an RPW:

Provide acreage estimates for jurisdictional wetlands in the review area: acres.

5. Wetlands adjacent to but not directly abutting an RPW that flow directly or indirectly into TNWs.

- Wetlands that do not directly abut an RPW, but when considered in combination with the tributary to which they are adjacent and with similarly situated adjacent wetlands, have a significant nexus with a TNW are jurisdictional. Data supporting this conclusion is provided at Section III.C.

Provide acreage estimates for jurisdictional wetlands in the review area: acres.

6. Wetlands adjacent to non-RPWs that flow directly or indirectly into TNWs.

- Wetlands adjacent to such waters, and have when considered in combination with the tributary to which they are adjacent and with similarly situated adjacent wetlands, have a significant nexus with a TNW are jurisdictional. Data supporting this conclusion is provided at Section III.C.

Provide estimates for jurisdictional wetlands in the review area: acres.

7. Impoundments of jurisdictional waters.⁹

As a general rule, the impoundment of a jurisdictional tributary remains jurisdictional.

Demonstrate that impoundment was created from "waters of the U.S.," or

Demonstrate that water meets the criteria for one of the categories presented above (1-6), or

Demonstrate that water is isolated with a nexus to commerce (see E below).

E. ISOLATED [INTERSTATE OR INTRA-STATE] WATERS, INCLUDING ISOLATED WETLANDS, THE USE, DEGRADATION OR DESTRUCTION OF WHICH COULD AFFECT INTERSTATE COMMERCE, INCLUDING ANY SUCH WATERS (CHECK ALL THAT APPLY):¹⁰

which are or could be used by interstate or foreign travelers for recreational or other purposes.

from which fish or shellfish are or could be taken and sold in interstate or foreign commerce.

which are or could be used for industrial purposes by industries in interstate commerce.

Interstate isolated waters. Explain:

Other factors. Explain:

Identify water body and summarize rationale supporting determination:

⁸See Footnote # 3.

⁹To complete the analysis refer to the key in Section III.D.6 of the Instructional Guidebook.

¹⁰Prior to asserting or declining CWA jurisdiction based solely on this category, Corps Districts will elevate the action to Corps and EPA HQ for review consistent with the process described in the Corps/EPA Memorandum Regarding CWA Act Jurisdiction Following Rapanos.

Provide estimates for jurisdictional waters in the review area (check all that apply):

- Tributary waters: linear feet width (ft).
- Other non-wetland waters: acres.
- Identify type(s) of waters:
- Wetlands: acres.

F. NON-JURISDICTIONAL WATERS, INCLUDING WETLANDS (CHECK ALL THAT APPLY):

- If potential wetlands were assessed within the review area, these areas did not meet the criteria in the 1987 Corps of Engineers Wetland Delineation Manual and/or appropriate Regional Supplements.
- Review area included isolated waters with no substantial nexus to interstate (or foreign) commerce.
 - Prior to the Jan 2001 Supreme Court decision in "SWANCC," the review area would have been regulated based solely on the "Migratory Bird Rule" (MBR).
- Waters do not meet the "Significant Nexus" standard, where such a finding is required for jurisdiction. Explain:
- Other: (explain, if not covered above):

Provide acreage estimates for non-jurisdictional waters in the review area, where the sole potential basis of jurisdiction is the MBR factors (i.e., presence of migratory birds, presence of endangered species, use of water for irrigated agriculture), using best professional judgment (check all that apply):

- Non-wetland waters (i.e., rivers, streams): linear feet width (ft).
- Lakes/ponds: acres.
- Other non-wetland waters: acres. List type of aquatic resource:
- Wetlands: acres.

Provide acreage estimates for non-jurisdictional waters in the review area that do not meet the "Significant Nexus" standard, where such a finding is required for jurisdiction (check all that apply):

- Non-wetland waters (i.e., rivers, streams): linear feet, width (ft).
- Lakes/ponds: acres.
- Other non-wetland waters: acres. List type of aquatic resource:
- Wetlands: acres.

SECTION IV: DATA SOURCES.

A. SUPPORTING DATA. Data reviewed for JD (check all that apply - checked items shall be included in case file and, where checked and requested, appropriately reference sources below):

- Maps, plans, plots or plat submitted by or on behalf of the applicant/consultant:
- Data sheets prepared/submitted by or on behalf of the applicant/consultant.
 - Office concurs with data sheets/delineation report.
 - Office does not concur with data sheets/delineation report.
- Data sheets prepared by the Corps:
- Corps navigable waters' study:
- U.S. Geological Survey Hydrologic Atlas:
 - USGS NHD data.
 - USGS 8 and 12 digit HUC maps.
- U.S. Geological Survey map(s). Cite scale & quad name:
- USDA Natural Resources Conservation Service Soil Survey. Citation:
- National wetlands inventory map(s). Cite name:
- State/Local wetland inventory map(s):
- FEMA/FIRM maps:
- 100-year Floodplain Elevation is: (National Geodetic Vertical Datum of 1929)
- Photographs: Aerial (Name & Date): Multiple year, Google Earth
or Other (Name & Date):
- Previous determination(s). File no. and date of response letter:
- Applicable/supporting case law:
- Applicable/supporting scientific literature:
- Other information (please specify):

B. ADDITIONAL COMMENTS TO SUPPORT JD:

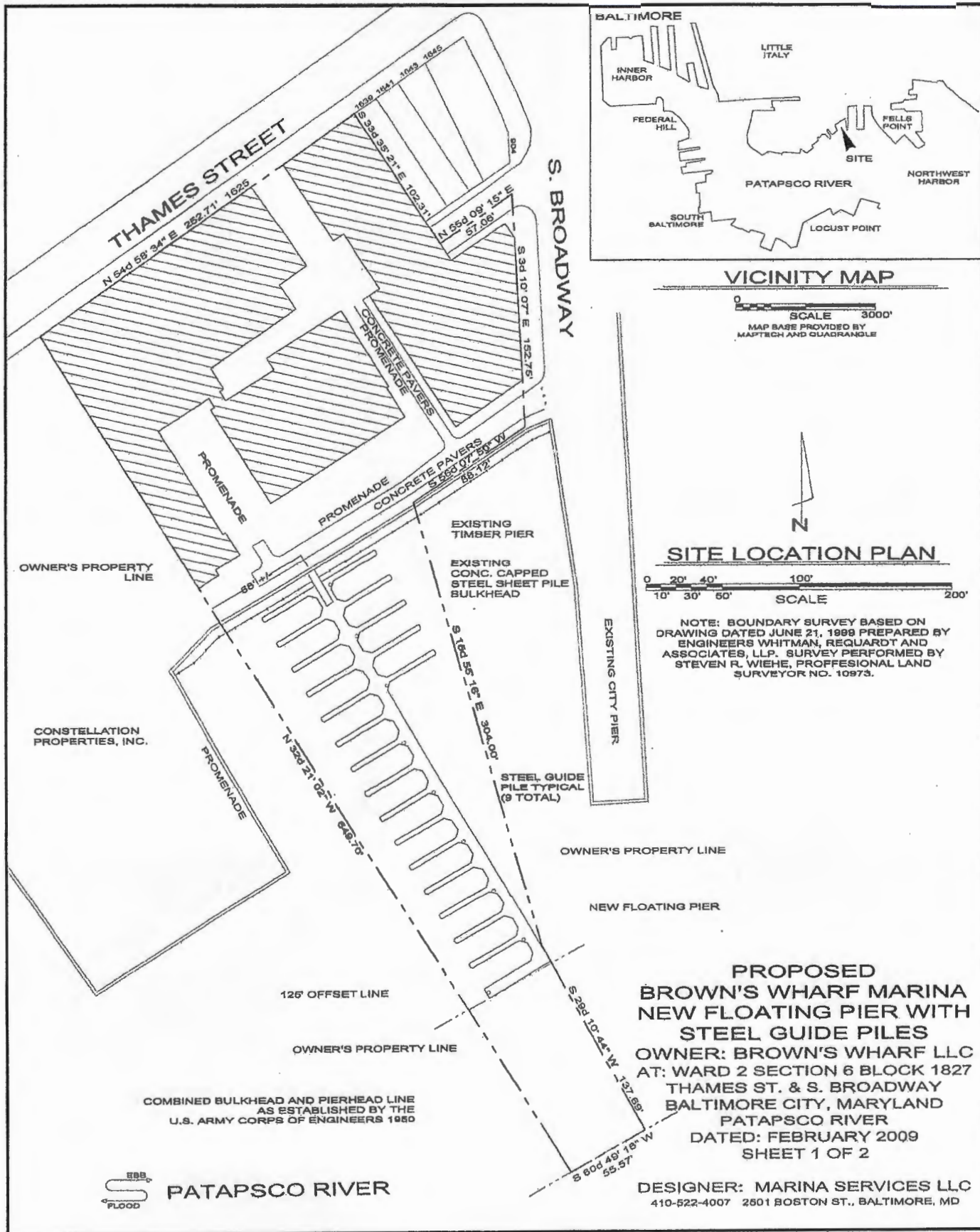

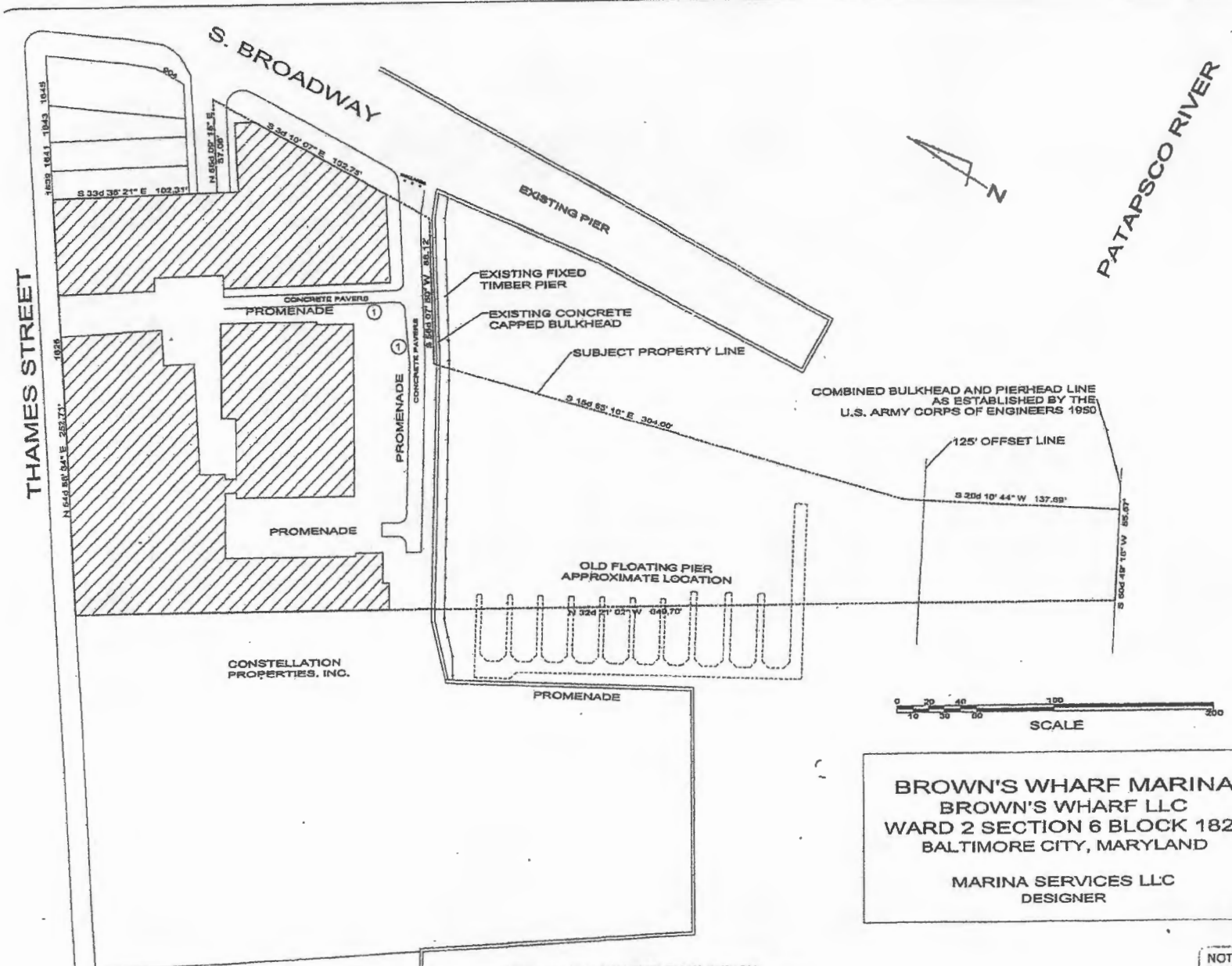

GENERAL NOTES

NO.	REVISION	DATE
①	CONC. PAVEMENT EGRESS	1/23/09

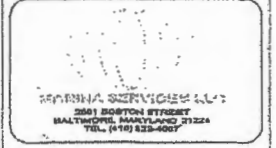

**MARINA DETAIL
PROPERTY PLAN**
BROWN'S WHARF MARINA
BALTIMORE, MARYLAND

DATE	DEC 2008	SHEET
SCALE	NTS	PP.1
DWG. NO.		
JOB NO.		

BROWN'S WHARF MARINA
BROWN'S WHARF LLC
WARD 2 SECTION 6 BLOCK 1827
BALTIMORE CITY, MARYLAND

MARINA SERVICES LLC
DESIGNER

NOTE: BOUNDARY SURVEY BASED ON DRAWING DATED JUNE 21, 1989 PREPARED BY ENGINEERS WHITMAN, REQUARDT AND ASSOCIATES, LLP. SURVEY PERFORMED BY STEVEN R. WIEHE, PROFESSIONAL LAND SURVEYOR NO. 10973.

NOTICE
Copyright 2009 by
MARINA SERVICES LLC
All rights reserved.
Reproduction or resale in
part without the
permission from
MARINA SERVICES LLC
is prohibited.

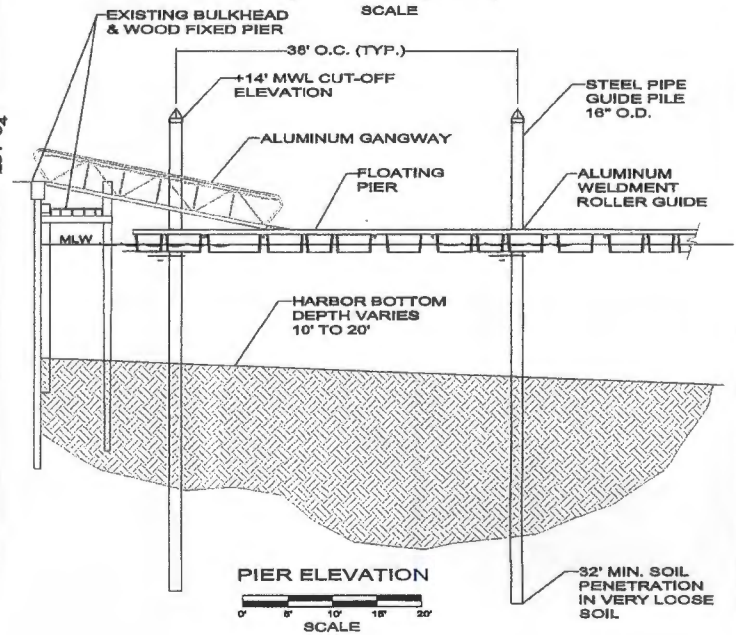
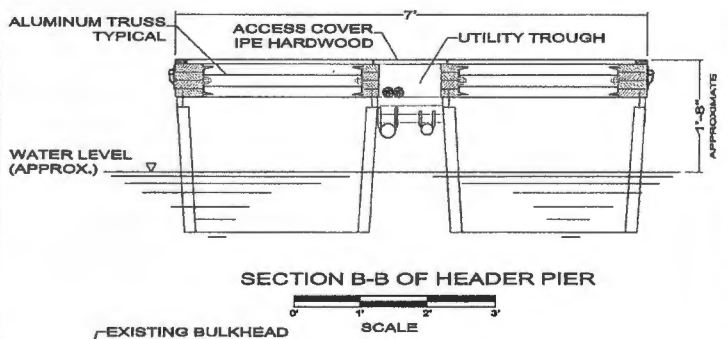
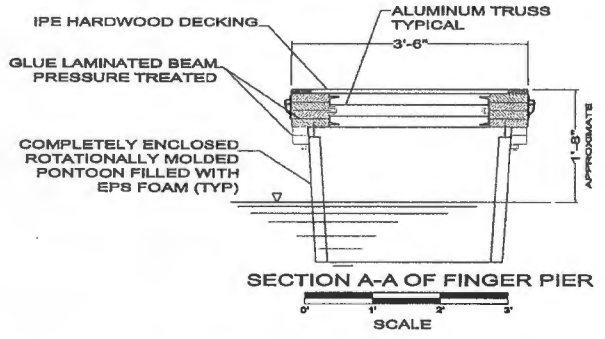
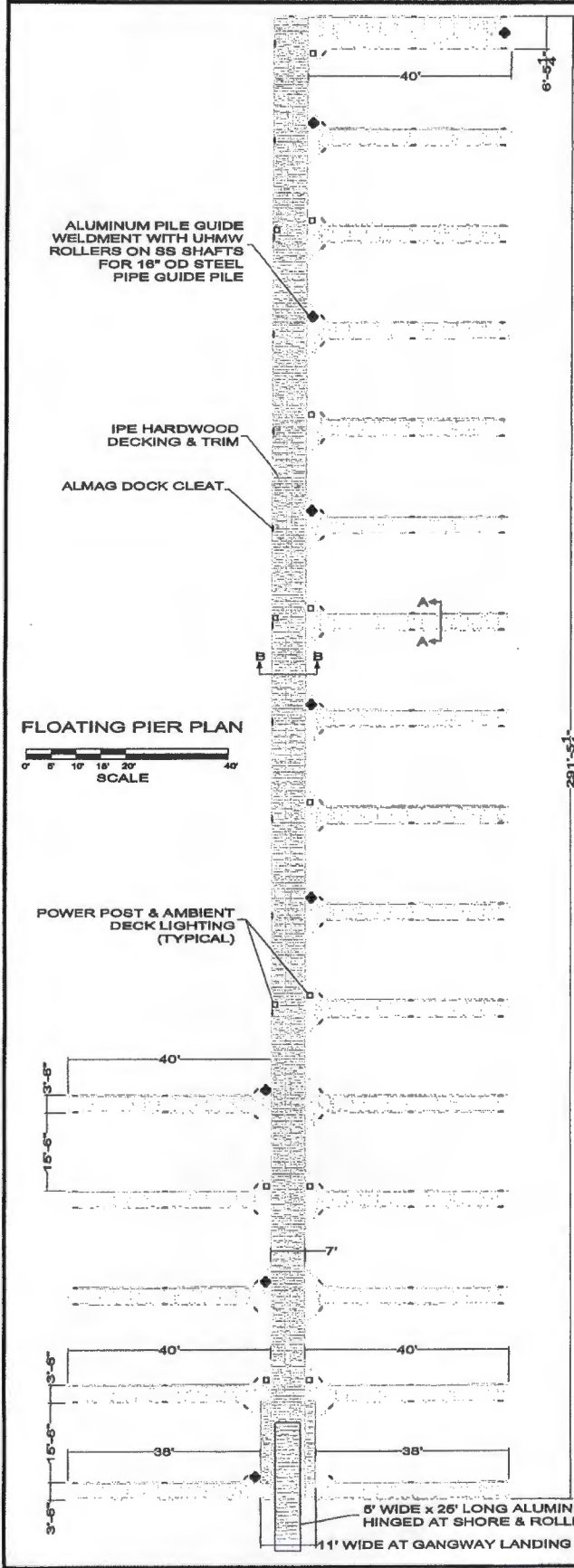

**PROPOSED
BROWN'S WHARF MARINA
NEW FLOATING PIER WITH
STEEL GUIDE PILES**

OWNER: BROWN'S WHARF LLC
 AT: WARD 2 SECTION 6 BLOCK 1827
 THAMES ST. & S. BROADWAY
 BALTIMORE CITY, MARYLAND
 PATAPSCO RIVER
 DATED: FEBRUARY 2009
 SHEET 2 OF 2

DESIGNER: MARINA SERVICES LLC
 410-522-4007 2801 BOSTON ST., BALTIMORE, MD